



CONTACTOR, AC-3 45 KW/400 V, AC 230 V, 50 HZ, 3-POLE, SIZE S3, SCREW CONNECTION

Figure similar

product brand name	SIRIUS
Product designation	power contactor
General technical data:	
Size of contactor	S3
Insulation voltage	
• Rated value	1 000 V
Degree of pollution	3
Surge voltage resistance Rated value	6 kV
Mechanical service life (switching cycles)	
• of the contactor typical	10 000 000
• of the contactor with added electronics-compatible auxiliary switch block typical	5 000 000
• of the contactor with added auxiliary switch block typical	10 000 000
Protection class IP	
• on the front	IP00
• of the terminal	IP00
Equipment marking	
• acc. to DIN EN 61346-2	Q
• acc. to DIN EN 81346-2	Q
Ambient conditions:	
Installation altitude at height above sea level maximum	2 000 m
Ambient temperature	
• during operation	-25 ... +60 °C

- during storage

-55 ... +80 °C

Main circuit:

Number of poles for main current circuit	3
Number of NC contacts for main contacts	0
Number of NO contacts for main contacts	3
Connectable conductor cross-section in main circuit at AC-1	
<ul style="list-style-type: none"> • at 60 °C minimum permissible 	35 mm ²
<ul style="list-style-type: none"> • at 40 °C minimum permissible 	50 mm ²
Operating current	
<ul style="list-style-type: none"> • at AC-1 at 400 V <ul style="list-style-type: none"> — at ambient temperature 40 °C Rated value 	120 A
<ul style="list-style-type: none"> • at AC-1 up to 690 V <ul style="list-style-type: none"> — at ambient temperature 40 °C Rated value — at ambient temperature 60 °C Rated value 	120 A 100 A
<ul style="list-style-type: none"> • at AC-3 <ul style="list-style-type: none"> — at 400 V Rated value — at 690 V Rated value 	95 A 58 A
<ul style="list-style-type: none"> • at AC-4 at 400 V Rated value 	80 A
Operating current for ≥ 200000 operating cycles at AC-4	
<ul style="list-style-type: none"> • at 400 V Rated value 	42 A
<ul style="list-style-type: none"> • at 690 V Rated value 	27 A
Operating current	
<ul style="list-style-type: none"> • with 1 current path at DC-1 <ul style="list-style-type: none"> — at 24 V Rated value — at 110 V Rated value 	100 A 9 A
<ul style="list-style-type: none"> • with 2 current paths in series at DC-1 <ul style="list-style-type: none"> — at 24 V Rated value — at 110 V Rated value 	100 A 100 A
<ul style="list-style-type: none"> • with 3 current paths in series at DC-1 <ul style="list-style-type: none"> — at 24 V Rated value — at 110 V Rated value 	100 A 100 A
Operating current	
<ul style="list-style-type: none"> • with 1 current path at DC-3 at DC-5 <ul style="list-style-type: none"> — at 24 V Rated value — at 110 V Rated value 	40 A 2.5 A
<ul style="list-style-type: none"> • with 2 current paths in series at DC-3 at DC-5 <ul style="list-style-type: none"> — at 110 V Rated value — at 24 V Rated value 	100 A 100 A
<ul style="list-style-type: none"> • with 3 current paths in series at DC-3 at DC-5 	

— at 110 V Rated value	100 A
— at 24 V Rated value	100 A
Operating power	
• at AC-1	
— at 230 V at 60 °C Rated value	38 kW
— at 690 V at 60 °C Rated value	114 kW
Operating power for ≥ 200000 operating cycles at AC-4	
• at 400 V Rated value	22 kW
• at 690 V Rated value	25.4 kW
Thermal short-time current restricted to 10 s	760 A
Active power loss at AC-3 at 400 V for rated value of the operating current per conductor	10.8 W
No-load switching frequency	
• with AC	5 000 1/h
Operating frequency	
• at AC-1 maximum	900 1/h
• at AC-2 maximum	350 1/h
• at AC-3 maximum	850 1/h
• at AC-4 maximum	250 1/h

Control circuit/ Control:

Type of voltage of the control supply voltage	AC
Control supply voltage with AC	
• at 50 Hz Rated value	230 V
• Rated value	50 Hz
Operating range factor control supply voltage rated value of the magnet coil with AC	
• at 50 Hz	0.8 ... 1.1
Apparent pick-up power of the magnet coil with AC	270 V·A
Inductive power factor with closing power of the coil	0.68
Apparent holding power of the magnet coil with AC	22 V·A
Inductive power factor with the holding power of the coil	0.27
Closing delay	
• with AC	17 ... 90 ms
Arcing time	10 ... 15 ms

Auxiliary circuit:

Number of NC contacts	
• for auxiliary contacts	
— instantaneous contact	0
Number of NO contacts	
• for auxiliary contacts	

— instantaneous contact	0
Operating current at AC-12 maximum	10 A
Operating current at AC-15	
• at 230 V Rated value	6 A
• at 400 V Rated value	3 A
Operating current at DC-12	
• at 60 V Rated value	6 A
• at 110 V Rated value	3 A
• at 220 V Rated value	1 A
Operating current at DC-13	
• at 24 V Rated value	10 A
• at 60 V Rated value	2 A
• at 110 V Rated value	1 A
• at 220 V Rated value	0.3 A
Contact reliability of the auxiliary contacts	1 faulty switching per 100 million (17 V, 1 mA)

UL/CSA ratings:

Contact rating of the auxiliary contacts acc. to UL	A600 / Q600
--	-------------

Short-circuit:

Design of the fuse link	
• for short-circuit protection of the main circuit	
— with type of assignment 1 required	fuse gL/gG: 250 A
— with type of assignment 2 required	fuse gL/gG: 160 A
• for short-circuit protection of the auxiliary switch required	fuse gL/gG: 10 A

Installation/ mounting/ dimensions:

Mounting type	screw and snap-on mounting onto 35 mm and 75 mm standard mounting rail
• Side-by-side mounting	Yes
Height	146 mm
Width	70 mm
Depth	139 mm
Required spacing	
• for grounded parts	
— at the side	6 mm

Connections/ Terminals:

Type of electrical connection	
• for main current circuit	screw-type terminals
• for auxiliary and control current circuit	screw-type terminals
Type of connectable conductor cross-section	
• for main contacts	
— solid	2x (2.5 ... 16 mm ²)

- stranded 2x (10 ... 50 mm²)
- single or multi-stranded 2x (2,5 ... 16 mm²)
- finely stranded with core end processing 2x (2.5 ... 35 mm²)
- finely stranded without core end processing 2x (10 ... 35 mm²)
- for AWG conductors for main contacts 2x (10 ... 1/0)





Type of connectable conductor cross-section

- for auxiliary contacts
 - solid 2x (0.5 ... 1.5 mm²), 2x (0.75 ... 2.5 mm²), max. 2x (0.75 ... 4 mm²)
 - finely stranded with core end processing 2x (0.5 ... 1.5 mm²), 2x (0.75 ... 2.5 mm²)
- for AWG conductors for auxiliary contacts 2x (20 ... 16), 2x (18 ... 14), 1x 12

Certificates/ approvals:

General Product Approval			Functional Safety/Safety of Machinery	Declaration of Conformity
 CCC	 CSA	 UL		 EG-Konf.

[Type Examination](#)

Test Certificates	Shipping Approval				
Special Test Certificate	 ABS	 GL	 LRS	 RINA	 RMRS

other
Environmental Confirmations Confirmation other

Further information

- Information- and Downloadcenter (Catalogs, Brochures,...)**
<http://www.siemens.com/industrial-controls/catalogs>
- Industry Mall (Online ordering system)**
<http://www.siemens.com/industrymall>
- Cax online generator**
<http://support.automation.siemens.com/WW/CAXorder/default.aspx?lang=en&mlfb=3RT10461AP00>
- Service&Support (Manuals, Certificates, Characteristics, FAQs,...)**
<https://support.industry.siemens.com/cs/ww/en/ps/3RT10461AP00>
- Image database (product images, 2D dimension drawings, 3D models, device circuit diagrams, EPLAN macros, ...)**
http://www.automation.siemens.com/bilddb/cax_de.aspx?mlfb=3RT10461AP00&lang=en

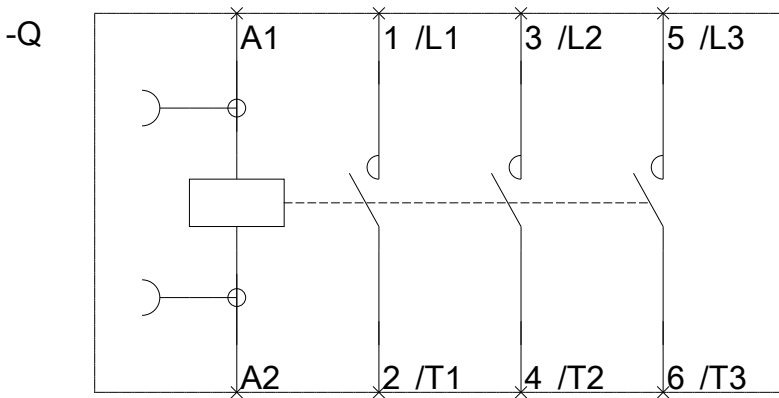
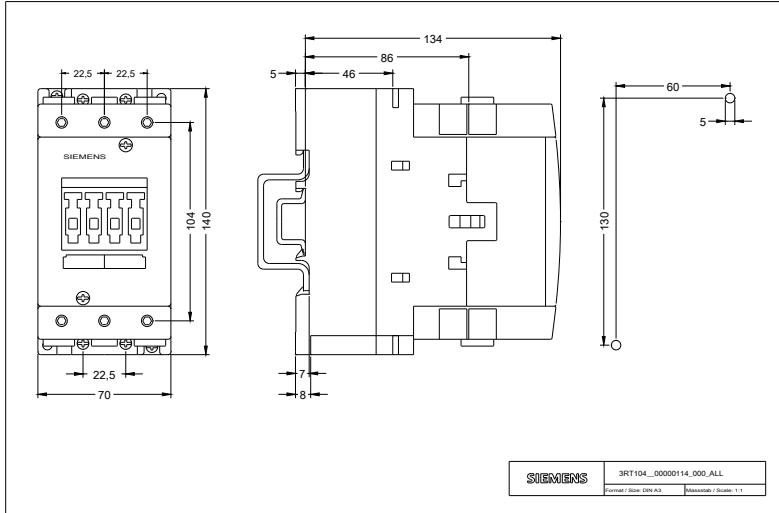

last modified:

02.06.2015